

NATIONAL INTREPID CENTER OF EXCELLENCE ANNUAL REPORT 2013

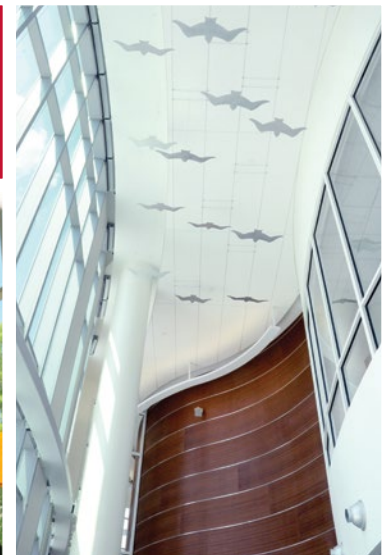

HOPE, HEALING, DISCOVERY AND LEARNING

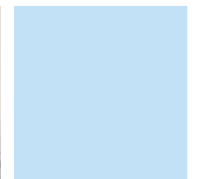

A LETTER TO STAKEHOLDERS FROM LEADERSHIP



Colleagues:

As our troops have withdrawn from Iraq and continue to withdraw from Afghanistan, the Military Health System (MHS) recognizes the need and value in caring for and learning more about traumatic brain injury (TBI) and psychological health (PH) conditions. While these wars may be winding down, we will continue to see this patient population for years to come making it essential to better understand these invisible wounds of war.

The National Intrepid Center of Excellence (NICoE) was established to fulfill a vital role in the MHS' continuum of care for service members suffering from comorbid, complex TBI/PH conditions. We have joined with providers across the MHS, including the Defense Centers of Excellence (DCoE), and Defense and Veterans Brain Injury Center (DVBIC) to care for this patient population.

We look forward to expanding upon these partnerships through the continued development of the NICoE network. This year, the NICoE Intrepid Spirit Satellite Centers opened at Fort Belvoir in Virginia on Sept. 11, 2013, and Camp Lejeune in Jacksonville, North Carolina on Oct. 2, 2013. The third Intrepid Spirit will open at Fort Campbell, Kentucky in the summer of 2014 and the fourth broke ground at Fort Bragg, North Carolina in January 2014.

We are honored to care for our nation's heroes. This first Annual Report summarizes our accomplishments in treating this complex patient population and highlights key events since the NICoE's ground breaking in 2010, recognizing achievements that have occurred as a result of the efforts of both the staff and its patients.

Our team has worked diligently to reach our goals and fulfill the NICoE's mission to deliver comprehensive and holistic care, conduct focused research, and share knowledge to benefit service members, their families and society. We are proud of our accomplishments to date. Throughout this report we will demonstrate how the NICoE is caring for and learning from our service members and their families, how we are conducting exciting and ground-breaking research, and how we are reaching out to the larger TBI/PH community. Examples of our work include:

- Treated 547 patients and provided 54,435 encounters
- Enrolled 1,345 participants in more than 13 different research studies
- Published 10 research articles and developed 15 ongoing research protocols
- Hosted 97 internal and external conferences and events at the NICoE alongside partner organizations in order to collaborate and share information
- Provided tours to more than 80 distinguished visitors including academic, military and political leaders as well as the media to learn more about what we do

As we move into 2014, we are excited to continue our work with increased focus on building relationships to more efficiently and effectively care for our patients, develop lessons learned and best practices, and extend the knowledge gained across the MHS.

Sincerely,

Sara M. Kass, M.D.

CAPT, USN, MC

NICoE Special Assistant to the Director

Walter Reed National Military Medical Center

James P. Kelly, M.D., FANA

NICoE Director



Table of Contents

I. MISSION	2
II. VISION	2
III. VALUE PROPOSITION	3
IV. HISTORY	4
V. INTERDISCIPLINARY, PATIENT AND FAMILY-CENTERED CARE	5
VI. INNOVATIVE RESEARCH ADVANCES UNDERSTANDING AND INFLUENCES TREATMENT OF TBI	12
VII. ENGAGING THE COMMUNITY THROUGH COLLABORATIVE EDUCATION AND OUTREACH	19
VIII. WHAT'S NEXT	23
ADDENDUM	29



I. MISSION

The National Intrepid Center of Excellence (the NICoE) is dedicated to advancing our understanding of traumatic brain injury (TBI) and psychological health (PH) conditions. We diagnose and initiate treatment for patients referred with complex, comorbid TBI/PH conditions; conduct focused research, and export knowledge and practices to improve TBI and PH outcomes for service members, their families and the Military Health System (MHS).

II. VISION

To be the nation's institute for TBI and PH dedicated to advancing science, enhancing understanding, maximizing health and relieving suffering.

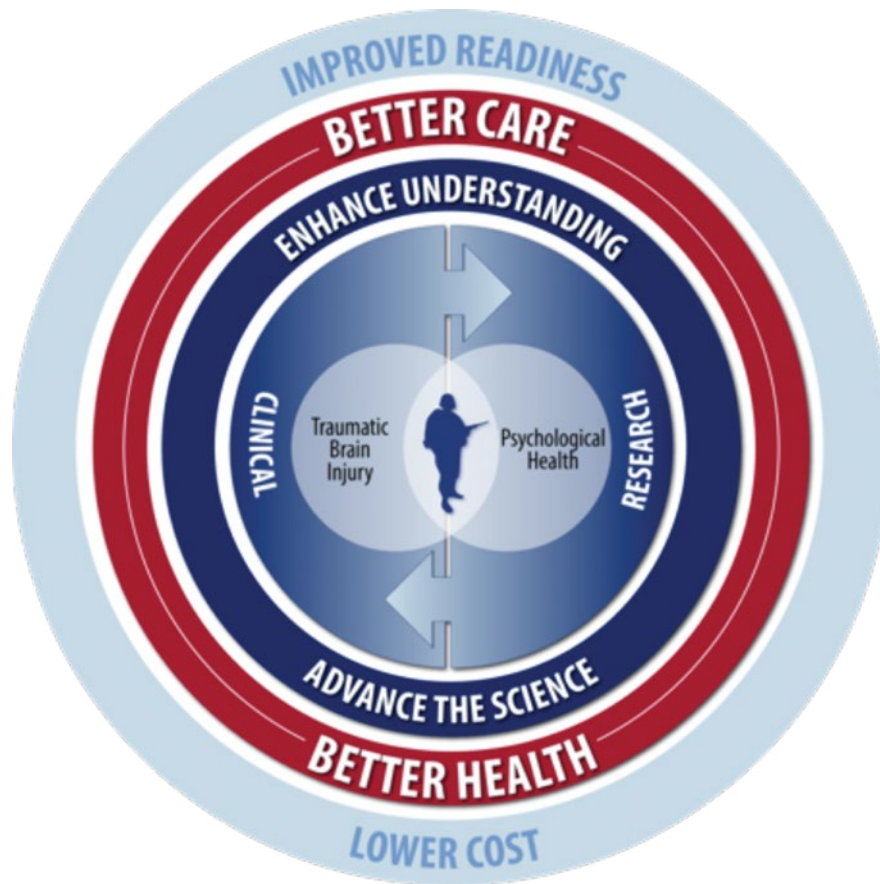

III. VALUE PROPOSITION

- Improve outcomes for patients with complex TBI and PH conditions by partnering with referring providers in interdisciplinary, multi-modal diagnosis and intensive treatment when indicated
- Conduct clinical research linking pathophysiology and interventions to improved outcomes leading to the development of new diagnostic and treatment approaches
- Partner to implement improvements across the MHS and demonstrate better outcomes in TBI and PH



The National Intrepid Center of Excellence is dedicated to treating the problem, not the symptom. They don't just give you treatment, they give you hope. And that's more valuable than anything.

- Lt. Pete Scobell,
Retired U.S. Navy SEAL

IV. HISTORY

In 2007, the Department of Defense (DoD) set out to create a center to advance our nation's understanding about the invisible wounds from the wars in Iraq and Afghanistan. This center would be designed to respond not only to the growing needs of those with comorbid TBI/PH conditions, but to also serve as a hub of research and

treatment that would influence care within the MHS.

The Intrepid Fallen Heroes Fund (IFHF), an independent non-profit organization that provides support to United States military personnel and their families, led the fundraising effort for the NICoE by securing \$65 million in private donations

and overseeing the construction and equipment of the facility. The 72,000 square-foot, two-story facility, located on the campus of Naval Support Activity Bethesda and home of the Walter Reed National Military Medical Center (WRNMMC), opened its doors to patients in October 2010.

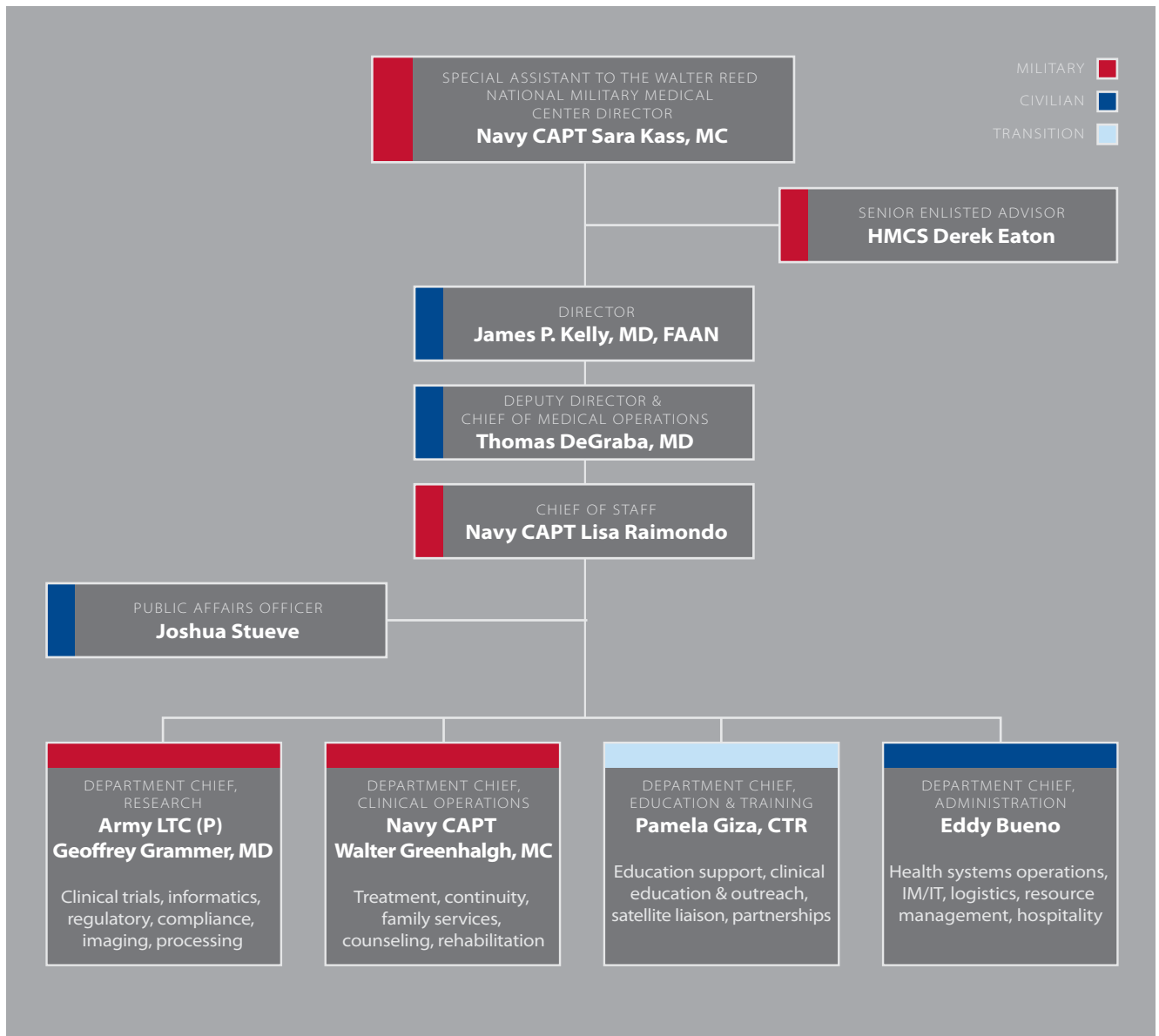

V. INTERDISCIPLINARY, PATIENT AND FAMILY-CENTERED CARE

Combat-related TBI and PH conditions affect thousands of service members and their loved ones each year. Brain injuries are the signature wound of the Iraq and Afghanistan wars¹ - almost 300,000 service members have been diagnosed with a TBI since 2000², and it is believed that between 10 and 20 percent of Iraq veterans have some degree of a TBI³.

The NICoE is dedicated to supporting this patient population's entire continuum of care, from intake to evaluation, treatment planning, discharge and follow-up. Partnering with military treatment facilities across the country begins prior to admission, ensuring a successful transition and discharge plan for each patient.

AN INTERDISCIPLINARY APPROACH TO CARE

Patients are referred to the NICoE when the treating provider identifies stalled recovery in a TBI/PH condition. The NICoE begins with an intake meeting on day one, where in one sitting, the patient meets with an interdisciplinary team of providers who collect a comprehensive patient history, perform a thorough clinical evaluation, and develop patient-centered, individualized treatment goals.

¹ <https://www.braintrauma.org/tbi-faqs/military-tbi/>

² <http://www.dvbic.org/dod-worldwide-numbers-tbi>

³ <https://www.braintrauma.org/tbi-faqs/military-tbi/>



“

There's a line in the Marines prayer, if I should miss the mark, give me the courage to try again. The NICoE gave me courage to hit that mark again. You find you're not the only one who had these problems; it's not your fault. Your bell was rung, and you need some rewiring.

– Major Stephen Taylor,
U.S. Marine

The unique co-location of this interdisciplinary team of providers allows this coordinated effort to continue throughout the patient's stay. The NICoE patients receive an average of 106 personalized provider encounters using specialized imaging and clinical equipment throughout the course of their 4-week outpatient stay.

This intensive, interdisciplinary care model merges behavioral health practices and neurology, allowing providers to diagnose and treat conditions that may have previously been unrecognized through routine clinical assessment, and thus change trajectory of recovery.

The NICoE's interdisciplinary approach has been replicated at the Intrepid Spirit Satellite Centers to ensure all patients and families receive this high degree of personalized care.

SEQUENCING OF EVALUATION TO IMPROVE DIAGNOSIS AND TREATMENT PLANNING

The NICoE focuses on partnering with patients to more effectively diagnose and treat their unique ailments. By sequencing patients evaluation and care to specifically target symptoms that are most disruptive to their lives such as sleep, pain or headache disturbance, the NICoE is able to work with patients to identify which symptoms may be most negatively affecting their quality of life.

This individualized level of care encourages patients to be an active participant in their evaluation and treatment, allowing them to build both alliance and trust with the NICoE providers. These efforts are important in ensuring patients and their family remain engaged with the interdisciplinary team and in future care.

ADDRESSING SLEEP DISTURBANCE

The Sleep Medicine Department addresses a full spectrum of sleep disorders including insomnia, circadian



Typical NICoE Evaluation and Treatments

- *Neurology*
- *Psychiatry*
- *Neuropsychology (including testing when needed)*
- *Speech-Language Pathology*
- *Internal Medicine/Family Medicine*
- *Optometry*
- *Nursing*
- *Audiology*
- *Radiology (MRI, PET/CT of the brain)*
- *Orthopedic Evaluation by Physical Therapist*
- *Comprehensive Vestibular Evaluation by Physical Therapist and Audiologist*
- *Social Work*
- *Sleep (including actigraphy and sleep study)*
- *Art Therapy*
- *Music Therapy*
- *Assistive Technology*
- *Biofeedback*
- *Acupuncture*
- *Wellness/Recreational Therapy*

Additional interventions

- *BOTOX*
- *Trigger Point Injections*
- *Acupuncture Treatments*
- *Biofeedback Treatments (including HeartMath)*
- *Microcurrent (including Frequency Specific Microcurrent and alpha-stim)*
- *Yoga*
- *Tai Chi*
- *Mind-Body Skill Building*
- *Group Therapy*
- *Education Course*
- *Journaling*
- *Recreation Therapy*
- *Animal Assisted Therapy*
- *Spirituality*
- *Nutrition*

sleep disorders, movement disorders of sleep, and sleep disordered breathing. The department is staffed by three physicians board certified in both neurology and sleep medicine, and two registered polysomnography (sleep study) technologists.

The sleep medicine department is fully integrated into the NICoE interdisciplinary model and works to promote sleep health, essential for recovery from TBI/PH conditions.

Notable developments in the department for 2013 include:

- Installation of new sleep equipment with an advanced database tool for focused research

- Bright light therapy for the treatment of circadian rhythm disorders and seasonal affective disorders
- Integrative medicine practices incorporated into the sleep laboratory to support cognitive behavioral treatment strategies for insomnia and to improve adherence of Continuous Positive Airway Pressure (CPAP) therapy
- Walk-in CPAP management clinics conducted by the polysomnography technologists where service members initiated on CPAP therapy are able return to the sleep lab for mask adjustments and mask refitting throughout the NICoE admission



Addressing pain is critical for successfully evaluating and treating the NICoE patients and the key to a positive overall experience. In order to do this, the NICoE successfully developed an internal pain management group that capitalizes on interventions employed by the Physical Therapy, Physical Medicine and Rehabilitation, Integrative Medicine, Wellness providers and Pharmacy departments.

This group uses interdisciplinary mind-body approaches such as acupuncture, biofeedback, meditation, movement, aquatic therapy and yoga to improve overall function for the patient.

Incorporating a holistic approach allows the service member to manage their pain so that they can actively engage in receiving care provided at the NICoE and beyond. Follow-on recommendations for pain management are important for a patient's future success once they leave the NICoE, and are included in the discharge summary for use at their referring location.

According to patient satisfaction surveys, 97.5 percent agreed that their providers did everything they could to help with their pain.





- An interscorer reliability program, a program that determines accurate interpretation and management of patients sleep lab data, initiated for quality assurance in the sleep studies

Once a patient's sleep and pain irregularities have been prioritized and addressed, the NICoE incorporates a high-tech approach to further evaluate TBI/PH related symptomology. The NICoE's experts leverage a wide array of state-of-art technologies to better understand the disease state of each patient. This information is used to develop an individualized treatment plan for the referring provider's use at the patient's home station.

INCORPORATING HOLISTIC AND INTEGRATIVE MEDICINE

The NICoE uses both a high-tech and high-touch, holistic approach to care in order to understand all of the elements that might be contributing to a patient's suffering. The interdisciplinary care model combines standard medical practices with integrative and family-centered care in a collaborative, holistic treatment approach that enhances patients' physical, mental and spiritual healing.

This integrative approach empowers service members and their families by instilling self-management skills and techniques to achieve balance,

personal well-being, and ultimately, long-term recovery.

PATIENT & FAMILY-CENTERED CARE

The NICoE realizes that a supportive family environment is crucial to managing TBI/PH symptoms, but family relationships are often strained due to personality changes caused by the TBI/PH condition. The NICoE works to meaningfully involve the family in all aspects of the service member's treatment and continued education. This effort was recognized in the 2013 Recovery Warrior Task Force Annual Report as a clinical best practice.

The social workers at the NICoE work with patients and their families in short-term, solutions focused family-therapy sessions, which are geared towards empowering patients and their families to manage life outside of the NICoE.

To support their efforts, the NICoE staff worked with 20 healthcare professionals from 13 different disciplines to create a comprehensive education program for patients with comorbid TBI/PH conditions. This innovative program consists of 20 hours of patient and family educational modules that teach core management skills.

These lesson plans and the accompanying materials, such as a patient workbook, provide standardized but customizable materials for service members and their families.



By providing caregivers with the tools they need to support their loved ones through related TBI/PH symptoms such as pain, sleep disruption and anxiety, the NICoE prepares service members and their families for continued recovery and healing after discharge.

ART THERAPY PROGRAM

The NICoE's Art Therapy Program is known throughout the MHS, academia and federal organizations. Art therapists help service members use art to improve communication, allow expression of feelings, improve coordination, and increase cognitive and social function.

In 2013, the NICoE participated in dozens of speaking engagements and outreach efforts around the world to share the art therapy work taking place at the NICoE. Experts showcased the impact that the program has on helping service members begin the healing process. Notable activities include:

- Invited as a guest of the British Military to present service members' art work at

England's annual Army Arts Society Exhibit

- Provided Congressional Arts Caucus and Senate briefings on Capitol Hill
- Gave presentations at the Arts and Health in the Military National Roundtable at the John F. Kennedy Center for the Performing Arts as well as WRNMMC's National Summit: Arts, Health and Well-being across the Military Continuum
- Featured in a profile in the Washington Post's and the Partnership for Public Service's "Federal Faces," which was accompanied by an online gallery of service member artwork that was highlighted on both 60 Minutes and NBC as well
- Invited to participate in the Americans for the Arts 2013 Arts and the Military Blog Salon, a week-long blogging forum to promote discussion around the use of the arts in the military
- Conducted multiple guest lectures at academic institutions such as the Uniformed Services University of the Health

Sciences (USUHS) and the University of Maryland

- Expanded the NICoE's partnership with the National Endowment for the Arts (NEA) to include therapeutic and creative writing and music therapy in addition to the visual arts therapy programs
- Expedited the NICoE Art Therapy Program to both the Fort Belvoir and Camp Lejeune Intrepid Spirit Satellite Centers

WARRIOR CANINE CONNECTION

The Warrior Canine Connection (WCC) is a therapeutic service dog training program. They work with service members suffering from post-traumatic stress disorder (PTSD) to train service dogs that are later partnered with mobility-impaired veterans.

Operating at the NICoE since 2011, the program draws upon the warrior ethos – a commitment to mission and team before self – to motivate emotionally numbed service members to help other service members.

MEASURES THAT MATTER

PATIENTS REPORTED CLINICALLY SIGNIFICANT IMPROVEMENTS IN STANDARDIZED ASSESSMENTS OF HEADACHE, SLEEP AND ANXIETY*

99%

OVERALL SATISFACTION RATE

92%

FEEL MORE HOPEFUL AFTER COMING TO THE NICoE

97%

AGREED PROVIDERS DID ALL THEY COULD WITH THEIR PAIN

EVERY NICoE PATIENT HAD A CLINICALLY SIGNIFICANT IMPROVEMENT IN AT LEAST ONE OF THE FOLLOWING SIX MEASURES:

30%

DIZZINESS HANDICAP INVENTORY

32%

SATISFACTION WITH LIFE SURVEY

36%

EPWORTH SLEEPINESS SCALE

46%

PTSD MILITARY CHECKLIST

52%

HEADACHE IMPACT TEST

67%

NEUROBEHAVIORAL SYMPTOM INVENTORY

**Reported by the 547 patients seen as of September 30, 2013*

At the NICoE, patients involved in the program report feeling less depressed and anxious, more willing to interact with others and better able to sleep. Their families benefit from their improved social and emotional skills.

The WCC serves four vital military missions:

1. Provide service members and veterans with PTSD and TBI the opportunity to be a part of a critical military support mission helping fellow wounded warriors
2. Offer a safe, effective and inexpensive non-pharmaceutical therapeutic intervention for PTSD

3. Train highly skilled service dogs that will provide years of mobility and social support to veterans with disabilities
4. Strengthen the bonds and relieve stress in military families

While a gap exists in best practices regarding placing service dogs with combat veterans with psychological health injuries, the WCC hopes to fill that void by working with the NICoE to create and disseminate best practices based on empirical research. For example, the NICoE hosted a summit with the Bob Woodruff Foundation to help define best practices in canine assisted therapy.

EVALUATING PATIENT OUTCOMES AND CAPTURING CLINICAL DATA

The NICoE collects clinical outcomes through measures that are administered to service members at the beginning and end of their stay. These include:

- Satisfaction with Life Scale
- Neurobehavioral Symptom Inventory
- PTSD Checklist
- Epworth Sleepiness Scale
- Dizziness Handicap Inventory
- Headache Impact Test
- Patient Health Questionnaire-9 (Depression)

The improvements in outcome measures captured at discharge not only show the impact of clinical treatment but also provide valuable data to inform and refine the NICoE's integrative, holistic model of care. The data helps the NICoE practitioners determine which interventions should be made more readily available to the patients.

According to patient surveys, when asked "Please indicate which techniques or tools you found most helpful in improving your recovery," the top five responses included: 1) Acupuncture, 2) Physical Therapy, 3) Mind/Body Skills, 4) Individual Counseling, 5) Biofeedback.

TRANSLATING CLINICAL EVALUATION INTO RESEARCH DATA

To accomplish the difficult task of collecting more than 43,000 data points per patient, the NICoE developed an informatics system. This Datamart leverages the

Triservice workflow Alternative Input Method (AIM) forms for AHLTA, and the Health Service Data Warehouse (HSDW). The NICoE drew upon the clinical expertise of 18 different disciplines to create AIM forms for the standardized collection of clinical data. This data will be key for future research activities on TBI/PH.

By customizing the organization's AIM forms to directly populate the NICoE Datamart within HSDW, researchers at the NICoE are able to further standardize front-end clinical data elements.

Additionally, the Common Data Elements (CDEs), a standardized language used to define specific biological TBI descriptors, found in the NICoE Datamart are submitted into the Federal Interagency TBI Research (FITBIR), a database which shares and connects multiple informatics platforms.

The FITBIR data can be used by any organization in the world and the collection of this data will enable further collaboration

and communication with key partners and other organizations involved in TBI research. The NICoE is a key contributor of this data, which is used for research articles, posters and presentations to deepen the knowledge of the larger academic TBI community.

Additional Patient-Focused Accomplishments

- Deployed United States Public Health Service staff assigned to the NICoE on three occasions in support of emergency situations for Hurricane Sandy, Sandy Hook Elementary School and the Boston Marathon bombing
- Supported expedition of NICoE interdisciplinary care model to two Satellite Centers in Fort Belvoir and Camp Lejeune as well as engaged with Satellites at Fort Campbell and Fort Bragg, which are expected to open in 2014

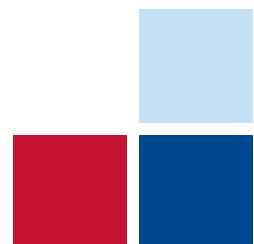

VI. INNOVATIVE RESEARCH ADVANCES UNDERSTANDING AND INFLUENCES TREATMENT OF TBI

“

The National Intrepid Center of Excellence has helped make my wounds visible. The wounds are on my brain, so if I wasn't missing an arm or I wasn't missing a leg, people didn't think there was anything wrong with me. To actually be able to get an MRI was very validating for me. I can actually at this point see my wounds—my hidden wounds. You get to the end of your rope and there's hope for you now.

– Todd Domorese,
Former U.S. Army Infantryman

As the medical community continues to increase its understanding of the mild TBI (mTBI)/PH population, patients with varying needs are often grouped into a single diagnostic category. The NICoE's research experts are currently using the latest neuroimaging technology available to begin to identify specific TBI biomarkers, the physiological footprint that is unique to each injury.

As the NICoE works towards compiling the world's largest database of TBI images, staff will be able to analyze the subtle distinctions and define which treatments are most effective for each type of TBI.

With a mission of assisting with the diagnosis, treatment

and prognosis of mTBI/PH, the NICoE's research agenda targets three specific goals:

- 1.** Identifying the combination of disease states that occur in the mTBI/PH population
- 2.** Understanding the underlying biological and psychological factors that contribute to our patients symptoms
- 3.** Determining how and why patients heal or fail to heal

These goals directly align with the White House's National Research Action Plan (NRAP), which focuses on improving access to mental health services for veterans, service members and their families.

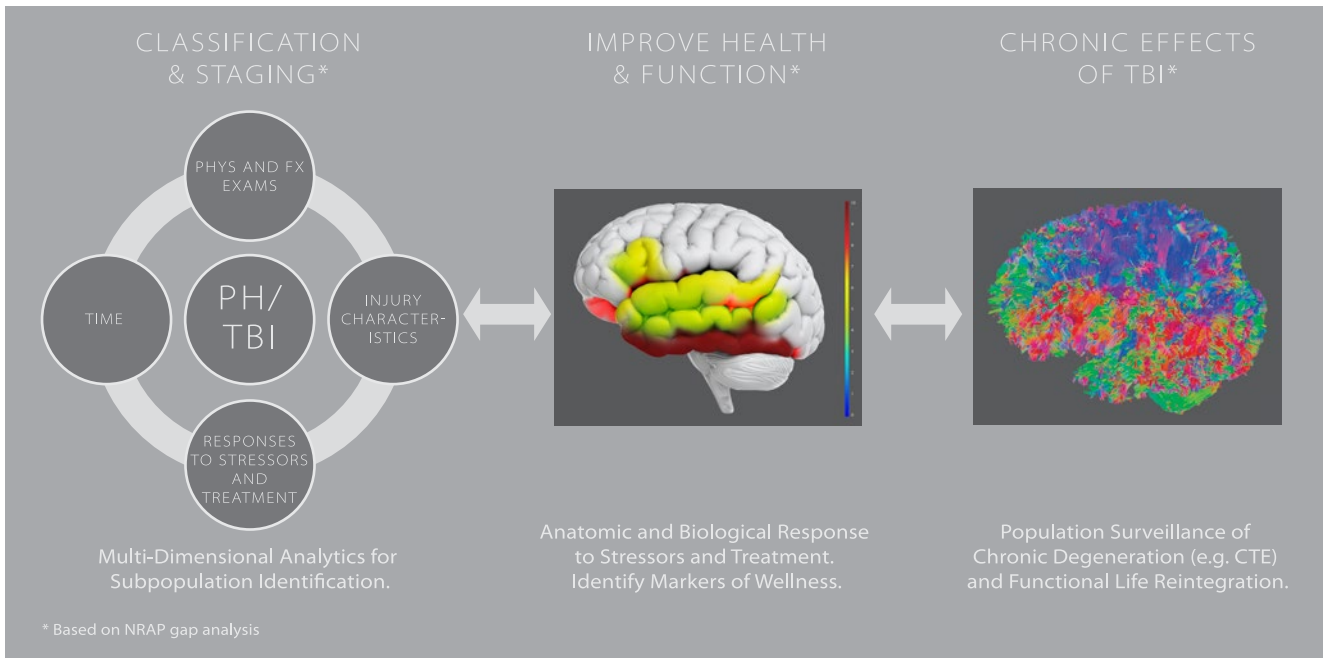

The NICoE research team initiated 15 innovative Institutional Review Board (IRB) -approved protocols to advance the evaluation and categorization of service members with the complex interaction of TBI/PH conditions.

These protocols are conducted in collaboration with other scientists and researchers in federal government, academia and private industry.

Each cohort of service members admitted to the NICoE helps advance the organization's mission by generating insight

into assessment, diagnosis and best practices, which in turn helps to inform and shape long-term research goals.

SETTING THE STANDARD FOR IMAGING RESEARCH

Conventional neuroimaging techniques rarely reveal abnormalities in mTBI/PH patients. The NICoE employs state-of-the-art diagnostic imaging modalities, including Magnetic Resonance Imaging (MRI), Positron Emission Tomography – Computed

Tomography (PET-CT), Magnetoencephalography (MEG) and Ultrasound, to detect structural and functional deficits that occur in this patient population.

Much work also goes into advance acquisition and image analysis to optimize the mechanics of image processing. The NICoE's scanners are located in adjacent rooms and are designed to provide detailed and complementary information about both anatomical and functional anomalies in the brain.

UNDERSTANDING MTBI BIOMARKERS THROUGH THE USE OF NEUROIMAGING

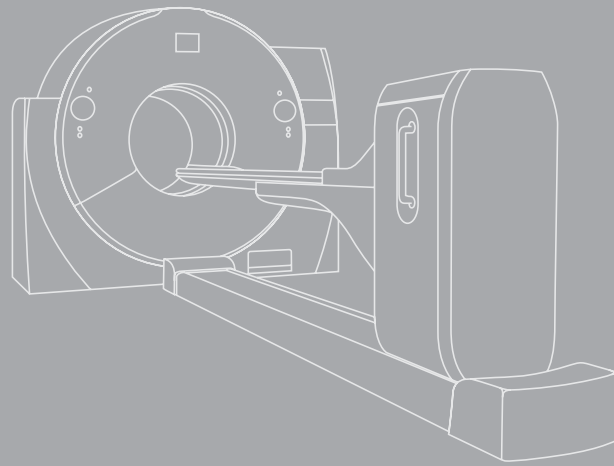

The overall goal of the neuroimaging research program is to identify objective biomarkers of TBI through a combination of information from multiple image modalities. Currently there is no standardized way of assessing the severity of traumatic axonal injury (TAI) in mTBI or predicting functional outcomes of mTBI patients.

In fact, for mTBI patients it is uncommon for an obvious lesion to be readily related to a specific functional deficit. Thus, the NiCoE has two main goals: 1) improve anatomic imaging techniques to optimize lesion detection in TBI; and 2) develop functional neuroimaging exams to focus on specific patient complaints, which invariably

are motivated by a functional problem.

The pictures below and on the next page show examples of high-resolution anatomic and functional MRI images.

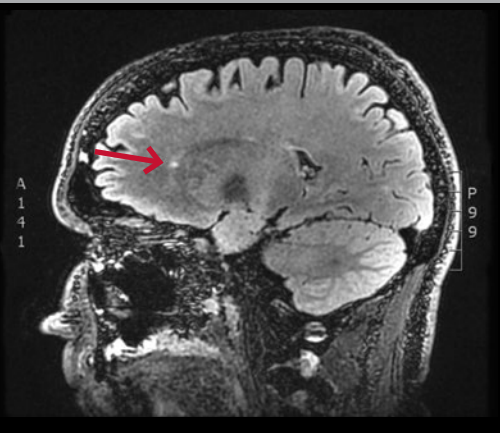

A WHITE-MATTER HYPERINTENSITY, THE MOST COMMON TYPE OF LESION DETECTED IN MTBI.

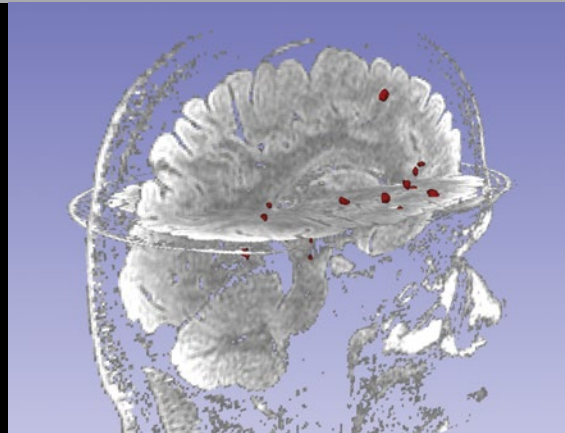

A GROUP OF WHITE MATTER HYPERINTENSITIES DETECTED IN A SINGLE PATIENT.



DEPICTION OF THE BRAIN SURFACE WITH NUMEROUS COLOR-CODED BRAIN REGIONS.

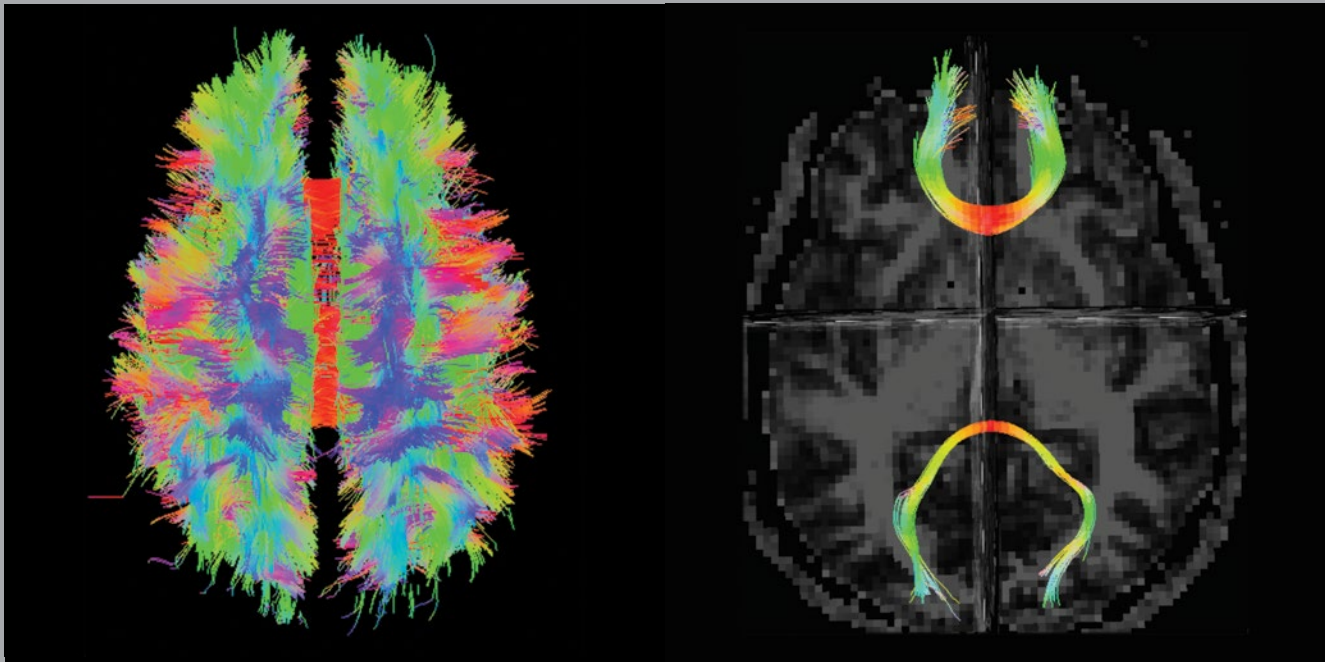

DIFFUSOR TENSOR IMAGING (DTI) DATA SHOWING ESTIMATIONS OF WHITE MATTER TRACTS THROUGHOUT THE BRAIN.

EXAMPLE OF SPECIFIC WHITE MATTER TRACTS (MAJOR AND MINOR FORCEPS), WHICH PROVIDES DETAILED INFORMATION ABOUT NEURAL PATH INTEGRITY.

FUNCTIONAL MRI ACTIVATION CLUSTERS

TYPICAL TBI SUBJECTS SHOW ACTIVATED (RED) AND DE-ACTIVATED REGIONS (BLUE).

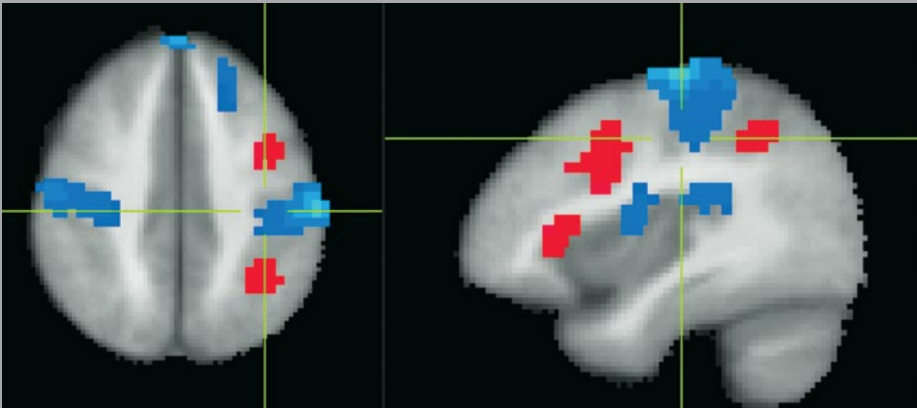

TBI SUBJECTS WITH ATTENTION DIFFICULTIES DO NOT SHOW A CORRESPONDING ACTIVATED REGION.

All images are courtesy of the NICoE.

MEG: EXPLORING THE BRAIN

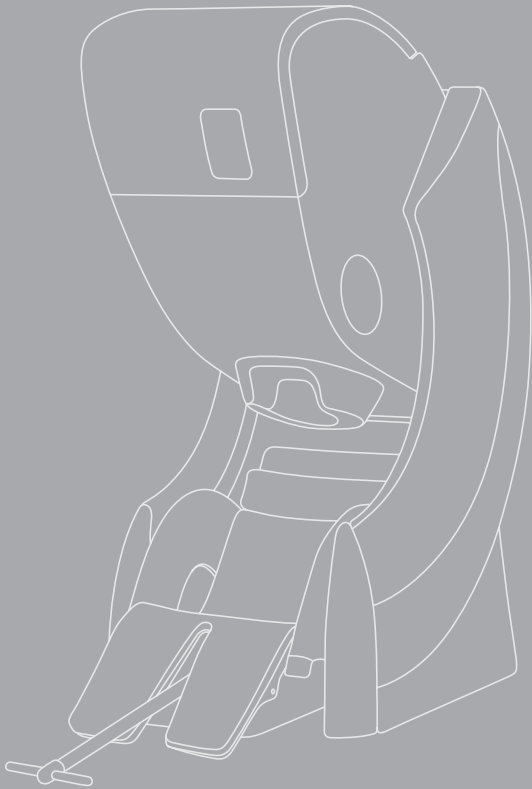

Magnetoencephalography (MEG) is a noninvasive, functional brain imaging technique that measures minute magnetic fields generated by electrical currents in neurons of the brain. The MEG allows for the exploration of spontaneous or evoked neuronal activities with a high temporal resolution.

As a consequence of this capability, it can provide unique insights into how different brain regions interact with each other and are recruited into functional

networks. The MEG is a powerful neuroimaging tool that can be used to understand the origin of diseases or to assess the effects of therapeutic treatments.

At the NICoE, MEG is used in conjunction with magnetic resonance techniques to discover the presence of abnormal brain waves indicative of subtle injury. Researchers are also using this tool to understand the unique or shared impact of TBI and PTSD on sensory, motor, cognitive or emotional functions of the brain.

Since opening its doors, the NICoE has scanned 655 patients with each MRI scan containing 41,000 images. This has resulted in an image library of almost 30 million images, the largest combat-related mTBI/PH image database in the world. These images are used to:

- Provide clinically relevant radiological information to the treatment team
- Relate structural lesions and functional activation patterns to clinical findings (demographic data, injury data, neuropsychiatric tests) to develop profiles for multiple TBI/PH categories
- Characterize structural and functional changes associated with long-term outcomes such as chronic traumatic encephalopathy (CTE)

The NICoE has been able to use its imaging data and results to help the Defense Centers of Excellence (DCoE) define, publish and disseminate emerging best practices for optimized MRI scan Developing Original Research Projects

The following examples of original research projects at the NICoE illustrate how researchers are influencing and improving the delivery of care across the MHS:



INFORMATICS DATABASE

The NICoE created a comprehensive database of mTBI/PH patients. All patients who have gone through the NICoE program are offered the opportunity to have their data captured into the database, including data from each of the clinical disciplines at the NICoE.

This complex data set identifies groupings of symptoms to allow characterization and sub-classification of the population.

Clinical outcomes for the first 2 years of NICoE patients were accepted for presentation at the American Psychiatric Association Conference and was submitted for publication to the Archives of Physical Medicine and Rehabilitation.

Results from multivariate data analysis resulted in 17 submissions for poster or presentation to the American Academy of Neurology, American Psychiatric Association, and NIH National Capitol Area Traumatic Brain Injury Symposium.

NEUROIMAGE ACQUISITION AND ANALYSIS

Neuroimaging efforts at the NICoE center around the organization's large neuroimaging database of military TBI patients. This database contains MRI structural and functional images from more than 600 military TBI patients and 45 control subjects.

The neuroimaging database is linked to the NICoE informatics database, providing a rich collection of information.

The neuroimage data are codified using the CDEs for TBI, and uses an innovative software tool that minimizes radiologist time while optimizing database interoperability. The database contains key data primarily from sub-acute to chronic TBI patients who are 3 months or more post-injury. This complements other prominent TBI research projects that have data from the acute phase of TBI, or may have pre- and post-injury data.

TBI AND PERFORMANCE

This study analyzes real-world multisensory processing of service members with TBI. Up to 60 percent of blast-related TBI cases result in impairment of ability to integrate audiovisual information into physical movement. Up to this point, there has been minimal research on how a TBI affects the ability of military personnel to perform these mission-critical tasks under high pressure.

The NICoE uses its state-of-the-art Computer-Assisted Rehabilitation Environment (CAREN) system to measure how well study participants perform audio-visual processing tasks while 1) standing still and 2) maneuvering over difficult terrain. The information from this study will help define return-to-duty standards for service members with TBI and also help develop rehabilitation strategies.

CAREN: VIRTUAL REALITY SUITE

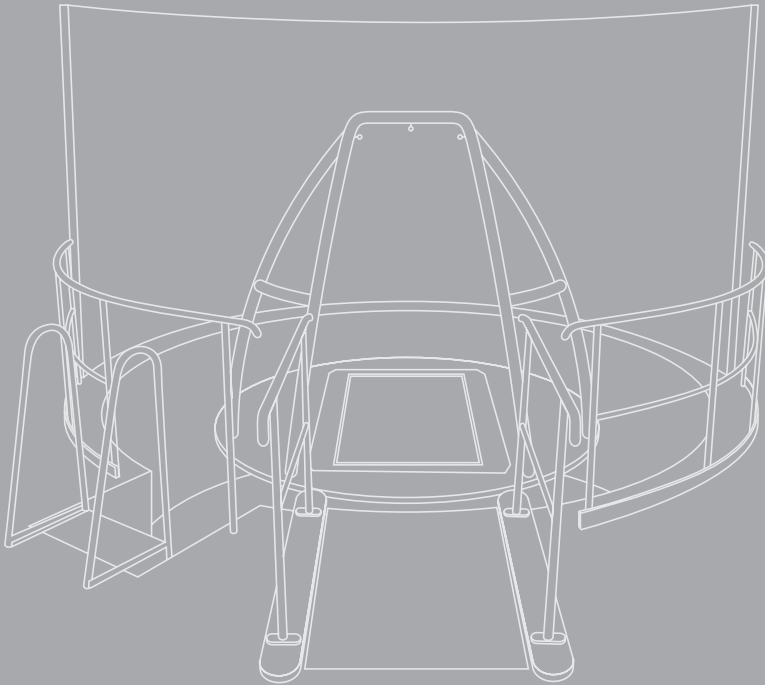

One of only 10 such machines in the world, the CAREN contains a motion platform with an embedded treadmill that moves in sync with virtual environments projected onto a large curved screen.

The CAREN is a technology that allows clinicians to further explore gait, motion sensitivity and balance as well as cognitive and visual scanning tasks. It does all of this by using virtual environments specifically developed to have therapeutic value. This approach allows service members to learn to interact with the “real world”

again but in a safe, controlled environment, and also allows the NICoE’s clinicians to better identify symptom-causing factors.

Additionally, due to the valuable feedback received from both patients and clinicians, clinical sessions allow relevant research questions to be formulated and refined into IRB approved research protocols.

As of Sept. 30, 2013, more than 195 NICoE patients were referred to the CAREN and over 376 clinical sessions were completed.

TEAM TBI

The NICoE was invited to partner with the University of Pittsburgh to participate in the Targeted Evaluation, Action and Monitoring (TEAM) TBI study. This U.S. Army Medical Research and Materiel Command (MRMC) grant funded study is developing innovative high definition neural tract mapping.

The goal is to establish evidentiary links between specific physical characteristics of TBI and individualized treatment protocols to maximize patient recovery.

Additional Research Accomplishments

- Selected as a training site for research electives for the National Capital Area Consortium Graduate Medical Education (GME) training program
- Submitted 10 peer-reviewed articles since the NICoE’s opening, seven of which were published in 2013, including two recent articles published in the journal *Frontiers in Neurology*
- Established a topic specific scientific review committee to expedite the review and approval of research protocols
- Instituted a Scientific Advisory Board to provide oversight, direction and strategic guidance to research initiatives and projects at the NICoE

VII. ENGAGING THE COMMUNITY THROUGH COLLABORATIVE EDUCATION AND OUTREACH

The NICoE is focused on developing partnerships with federal, academic and private organizations to advance the pathophysiological understanding of TBI/PH and share research, best practices and educational opportunities.

Even as current conflicts begin to wind down and service members return from combat deployments around the world, the need for focused TBI/PH research and care will only increase. The NICoE meets this need by serving as an intellectual hub and resource for TBI/PH information, education and research for the MHS and beyond.

PARTNERSHIPS

Through its partnership with the NEA, the Healing Arts Program at the NICoE has flourished, employing many different types of artistic and creative modalities, such as therapeutic and creative writing, music therapy, and visual arts therapy.

Together, these modalities complement each other and serve as a means of therapy and expression for service members with comorbid TBI/PH conditions. In November 2013, the partnership announced the exciting expansion of the NICoE

Art Therapy Program to Fort Belvoir's Intrepid Spirit NICoE Satellite.

Another growing partnership opportunity at the NICoE is the International TBI CDEs Project, where the NICoE is currently partnering with a wide array of organizations. This collaborative effort among the National Institutes of Health, DoD, National Institute on Disability and Rehabilitation Research, Department of Veterans Affairs and the Centers for Disease Control and Prevention aims to standardize definitions and protocols for TBI research.

Hundreds of experts from around the world who are affiliated with these organizations have developed recommendations for identifying, categorizing and collecting TBI-related data in a standardized manner. This will allow the entire neurological community to speak a common scientific language in order to clearly define the various degrees of a TBI and simplify long-term diagnoses and treatment.

The NICoE also works with several other leading institutions to further its mission in understanding and treating comorbid TBI/PH conditions.



NICOE'S FORMAL PARTNERSHIPS

PARTNER	DESCRIPTION
Center for Neuroscience and Regenerative Medicine	Ongoing protocols of evaluation of magnetic stimulation and imaging
Defense and Veterans Brain Injury Center	Conducting imaging for several key studies, brain indices of risk and exploring the natural history of TBI within a military cohort; Transcranial Magnetic Stimulation (TMS) research for PTSD and mTBI
Drexel University	Submission of Healing Arts NIH R01 grant to assess the efficacy of art therapy in the treatment of service members with TBI and PTSD
Fort Carson Evans Army Community Hospital, Massachusetts General Hospital and University of Utah	Ongoing collaborative study looking at the effects of hyperbaric oxygen in TBI
The George Washington University	Technical internship for Art Therapy as a therapeutic modality
Harvard University	Study evaluating the relationship of genomic expression with integrative medicine
The National Institute of Mental Health	Use of consultative and scientific expertise of MEG technology
The National Endowment of the Arts	Memorandum Of Understanding to support Operation Homecoming, a writing workshop for wounded warriors. MOU expanded to support Music Therapy for WRNMMC
Naval Medical Research Center	Collaboration for MEG research using halftime asset
The NiCoE Satellite Network	Ongoing coordination of patient assessment and outcome measures
Uniformed Services University of the Health Sciences	Conducting imaging for several key studies, virtual reality therapy and enhancing exposure therapy for PTSD; collaboration on autonomic research lab; TMS research for PTSD and mTBI; animal assisted therapy; and collaboration with translational imaging lab
The University of Delaware	Technical Internship with the CAREN Operator
The University of North Carolina	Proposals for autonomic/heart rate variability in animal assisted therapy (Congressionally Directed Medical Research Programs grant) and healing arts (NIH R01 grant)
The University of Pittsburgh	Serving as a pilot site for the TEAM-TBI project led by the University of Pittsburgh focused on new cutting-edge imaging modalities
The Walter Reed Army Institute of Research (WRAIR)	Multiple ongoing protocols
The Walter Reed National Military Medical Center	Multiple research protocols and clinical collaboration

INFORMAL PARTNERSHIPS AND FORUMS

In addition to the NiCoE's formal partnerships, the organization provides continual forums to communicate and educate with the TBI/PH community. Activities such as facility tours, conference and

events, video conferencing, and working with the student academic community help the NiCoE increase awareness of and continue a dialogue about TBI/PH issues.



PROJECT ECHO

Project ECHO (Extension for Community Healthcare Outcomes), a bi-monthly video tele-education conference, created in collaboration with the University of New Mexico, invites attendees to share clinically significant case studies from the TBI/PH medical community. As many as 25 locations participate, allowing for discussion around emerging best practices and subsequent implementation in treatment.

During fiscal year 2013, the NICoE facilitated five Project ECHO sessions, providing over 230 Continuing Education Units (CEUs) to medical providers in various geographic locations. Through lessons learned and information sharing, Project ECHO influences care delivery and reaches a large range of clinicians across the country.

THE NICoE ACADEMIC PROGRAM

The NICoE Academic Program provides opportunities for students to further their education and awareness of TBI/PH and instill interest in future service with military medicine or the private sector. In the summer of 2013, the NICoE supported nine Student Clinical Observation Opportunity Program (SCOOP) students, 12 Red Cross Research Assistance

Students and 10 medical students and residents for academic rotations.

Students studied topics including:

- Efficiency of mobile applications in TBI assessment and treatment of the effectiveness of different medications used in mobile TBI treatment
- Incidence, location and shape of MRI lesions in TBI patients
- Frequency of diagnoses like PTSD, insomnia and mood disorders among service members at discharge

By engaging students in this field of study, the NICoE is helping to prepare the next generation of researchers and clinicians to be better equipped and interested in working with this patient population.

HUB OF INTELLECTUAL EXCHANGE

Serving as a hub for both developing and sharing knowledge related to TBI/PH research and treatment, the NICoE opened its doors to more than 80 distinguished visitors including members from Senior Military Officers, Members of Congress, research organizations, professional sports teams and other

interested organizations such as the U.S. Olympic Diving Team.

These visitors are shown how the NICoE's state-of-the-art technology, science and staff change the lives of service members living with TBI/PH. These visitors often become champions of the NICoE's mission and vision for improving quality of care in this patient population.

The NICoE has hosted 97 conferences, symposiums and events since opening its doors. These events enhance partnerships between the military, federal, academic and private industry partners and facilitate the advancement of research and treatment. Additionally, the NICoE's clinicians are frequently requested to speak as subject matter experts in a variety of disciplines for professional organizations.

The NICoE was honored to participate in First Lady Michelle Obama's Joining Forces initiative in January 2013. This national initiative brings attention to the unique needs and strengths of military families and critical health and wellness issues facing service members. The event was hosted at the NICoE to discuss TBI/PH among service members and to share new understandings of these conditions between the MHS and civilian academia.



The event brought together more than 100 U.S. medical schools and numerous professional organizations including the American Medical Association, the American Nurses Association, National Association of Social Workers, American Psychological Association, American College of Physicians, American College of Surgeons and the Association of American Medical Colleges.

Additional Outreach Accomplishments

- Hosted and participated in two CDC/DoD/VA/Health and Human Services (HHS) meetings focused on refinement of the national standard definition of TBI

- Organized the NICoE Satellite Clinical Coalition to continually support collaboration between the NICoE Satellites, the NICoE Institute and other DoD and VA partners to advance the body of knowledge surrounding delivery of care to service members with TBI —with or without comorbid PH conditions
- Established communities of practice for different disciplines at the NICoE to share and disseminate best practices with fellow clinical providers at the NICoE Satellites

VIII. WHAT'S NEXT

As the NICoE continues its mission and Satellite Centers open their doors to patient care, the NICoE is well positioned to become a world-class clinical research institute that: 1) advances the science of TBI/PH conditions; and 2) improves practice standards and health outcomes in the patient population across the MHS, VA and civilian sectors. In pursuit of these goals during 2014, the NICoE will focus on:

- Maximizing efficient and effective use of the NICoE's talent
- Translating clinical observations and discoveries to clinical recommendations for standardization of care with improved outcomes
- Strengthening infrastructure and processes to align with the defined research agenda
- Continuing research collaborations and information sharing with key organizations and Satellites
- Engaging internal and external partners in effectively communicating the NICoE's distinct mission

MAXIMIZING EFFICIENT AND EFFECTIVE USE OF THE NICoE'S TALENT

Moving forward into 2014, the organization will continue to improve efficiencies to better leverage NICoE's greatest assets – its dedicated staff. Individuals will not only be empowered to succeed, but will be encouraged to engage in the clinical and research objectives of the organization.

These practices will highlight areas in which fresh and innovative talent can be employed to assist the NICoE in furthering its mission and vision.

TRANSLATING CLINICAL OBSERVATIONS AND DISCOVERIES INTO CLINICAL RECOMMENDATIONS

Since no two TBI conditions are alike, individuals differ significantly in their response to therapies. Identifying patterns among treatment options and mapping their effects on specific patient cohorts is imperative to advancing the science and understanding of TBI/PH.

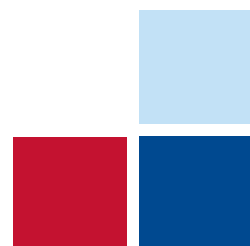

By gathering and studying quantitative and qualitative clinical presentation data and patient outcome metrics, the NICoE's clinical platform will validate the correlation between presenting symptomology and specific treatment modalities and intervention. With clinical and research working together to gather, verify and analyze data, the NICoE's best practices can be more easily translated for adoption throughout the MHS. This, in turn, will result in improved outcomes for service members.

STRENGTHENING INFRASTRUCTURE AND PROCESSES TO ALIGN WITH THE RESEARCH AGENDA

Through research, the NICoE has a tremendous opportunity to influence service member

care, as well as become the military's recognized clinical research institute for TBI/PH. In order to make this possibility a reality, and clarify its role within a diverse set of communities, the NICoE will focus on developing a robust and effective mechanism by which to conduct research.

Specifically, the NICoE will pursue research projects that are associated with their defined agenda and partner with other organizations on relevant questions aligned to the NRAP. Instituting concrete, organization-wide procedures will yield more comprehensive data that is easily collected and analyzed and, therefore, better able to address questions that are specific to the TBI/PH patient population.

COLLABORATIONS AND INFORMATION SHARING WITH KEY ORGANIZATIONS AND SATELLITES

In addition to internal efforts, the NICoE will continue to pursue meaningful relationships with affiliates and Satellites. Facilitating partnerships will expand the data sharing opportunities for clinical research collaboration across the NICoE Network and, in turn, the

overall body of knowledge on the physiological effects of TBI/PH.

The NICoE will collaborate with partner organizations to share best practices via Video Teleconferences and Grand Rounds. These events will not only increase general awareness for TBI/PH care and long-term symptom management, but it will ensure that discoveries which occur in one location are shared across the MHS to improve care for thousands of service members.

ENGAGING INTERNAL AND EXTERNAL PARTNERS IN EFFECTIVE COMMUNICATION

While communications via information sharing is vital, engaging internal and external stakeholders will involve spreading a clear message about the NICoE's value. Done effectively, this will allow the organization to maximize its reach and share its innovative approaches with key partners throughout the MHS. Consistency – both in content and timing – is key and will highlight the NICoE's activities in a well-defined and relatable manner.



ACTIVE RESEARCH PROTOCOLS OF 2013

All research at the NiCoE is preceded by Institutional Review Board (IRB) approval of protocols and informed consent from all subjects.

START DATE	STUDY NAME AND DESCRIPTION	INSTITUTIONAL AFFILIATIONS	STATUS UPDATE
January 2014	<p>Advanced Imaging Acquisition and Data Analysis for a Military TBI Neuroimaging Database</p> <p>Acquire a defined group of advanced but clinically feasible neuroimaging studies on eligible TBI patients to determine the most effective imaging methods for characterizing and tracking the disease state. The highly individualized nature of TBI necessitates a large number of subjects to discover distinct sub-categories of TBI symptomatology. The power of this database lies in the enrollment of over 500 subjects in this study. This study combines multiple modalities of MRI and PET, and hypothesizes that TBI diagnosis will result from careful characterization of individual modalities followed by advanced multi-modal analysis.</p>	Internal to the NiCoE	This project has completed Phase I of data collection. Advanced data analysis is underway. Using this database we are developing a new technique of analyzing images that allows personalized identification and detection of lesions in individual patients with mTBI/PTSD. Research helped shape DVVIC clinical recommendations.
November 2013	<p>Dual-Task Assessment using the CAREN: Implications for Service Members with Co-morbid mTBI and PTSD</p> <p>The goal of this study is to compare outcome measures obtained from a conventional dual task assessment, to a CAREN dual task assessment in order to determine whether the CAREN can provide additional insight into dual task performance for service members with comorbid mTBI and PTSD.</p>	Internal to the NiCoE	Currently enrolling subjects and controls.
June 2013	<p>Assessing the Impact of mTBI on Multisensory Integration While Maneuvering on Foot</p> <p>To evaluate auditory-visual-vestibular integration by measuring the localization error and reaction time required to identify a target with and without visual/audio cues in both static and walking conditions by normal participants and by participants diagnosed with mTBI as a result of military deployment.</p>	Walter Reed National Military Medical Center (WRNMMC)	Currently enrolling patients, 50 subjects and 50 controls.
April 2013	<p>Exploring the Natural History of Traumatic Brain Injury within a Military Cohort - A Longitudinal Database</p> <p>The study seeks to improve understanding of TBI by developing a database that contains important TBI-related information. The study is sponsored by DVVIC, with funding provided by the DoD. The goal of the study is to generate information that policy makers can use to improve the care of service members with TBI. The data collected for the study will provide the foundation for the development of hypothesis-driven protocols.</p>	WRNMMC Fort Belvoir DVVIC	Conducting image analysis of data.
October 2012	<p>Enhancing Exposure Therapy for PTSD: VR & Imaginal Exposure with a Cognitive Enhancer</p> <p>To identify the superior method for treating PTSD and determine the efficacy of D-Cycloserine (DCS) for augmenting both Virtual Reality Exposure (VRE) as well as Prolonged Exposure (PE). Using a 2 by 2 design, participants will be randomized to receive either VRE or PE, in conjunction with random selection to a cognitive enhancer called DCS or a placebo/inactive agent. The four groups will then be compared: VRE plus DCS, VRE plus placebo, PE plus DCS, and PE plus placebo.</p>	USUHS Emory University Weill Cornell Medical College in New York City Veterans Administration Hospital in Los Angeles Institute for Creative Technologies at the University of Southern California	Currently enrolling subjects and controls. Recently featured on Federal News Radio WTOP as an innovative study to watch as results become available.

START DATE	STUDY NAME AND DESCRIPTION	INSTITUTIONAL AFFILIATIONS	STATUS UPDATE
July 2012	<p>The Community Balance and Mobility Scale: Assessment of Service Members with mTBI and PTSD</p> <p>To establish a collection of results for the Community Balance and Mobility scale test and compare data for the Activities-specific Confidence Scale, Functional Gait Assessment and gait speed in active duty service members with and without a history of mTBI and PTSD.</p>	Internal to the NiCoE	Recruited 65 TBI subjects. Awaiting enrollment for controls.
July 2012	<p>Brain Injury and Mechanisms of Action of HBO2 for Persistent Post-Concussive Symptoms after mTBI</p> <p>Describe the brain function and anatomy of active duty personnel with Post Concussive Syndrome (PCS) using a comprehensive battery of assessments, across time to receive intervention (hyperbaric oxygen) or sham control, and explore potential associations between changes in function, anatomy, and participant reported outcomes. RETURNThe role of NiCoE is to supervise and perform analysis for neuroimage data, and to integrate these results with other clinical measures.</p>	University of Utah EACH Fort Carson, CO Las Vegas Imaging Center Martinos Center Massachusetts General Hospital/ Harvard	Data collection for Phase I began November 2012 and will continue through July 2014. Phase II, if approved, will enroll subjects for an additional 2 years. Approximately 50 subjects have been enrolled to date.
June 2012	<p>Differential Assessment of mTBI and PTSD Using Functional Brain Imaging Techniques (MEG/EEG)</p> <p>To characterize mTBI with the utility of the MEG. Various tasks are employed to assess different areas of cognition amongst service members with a diagnosis of mTBI, PTSD and controls.</p>	WRAIR	The NiCoE has identified disruption in neural networks in patients without previously identified neurologic lesions.
May 2012	<p>Integration of Image and Clinical Measurements of TBI Patients Using Machine Learning Techniques</p> <p>To perform a methodical and in-depth assessment of how data mining techniques can be used to integrate multimodal clinical data coming from different TBI evaluations. In order to effectively characterize the biological state of patients with mTBI/PTSD, a large collection of multi-modal clinical variables must be considered, evaluated, and modeled simultaneously using advanced analytical and data mining techniques.</p>	Internal to the NiCoE	Conducting retrospective data collection.
April 2012	<p>The National Intrepid Center of Excellence (NiCoE) Clinical Research Database to Study the Natural History of Traumatic Brain Injury and Psychological Health Outcomes in Military Personnel</p> <p>To improve the understanding of TBI, PTSD and other PH conditions. Comprehensive data will be collected and maintained from service members enrolled at the NiCoE, as a means of analyzing injuries, symptoms and efficacy of treatment being utilized at the NiCoE.</p>	Internal to the NiCoE	More than 97% of all patients enrolled at the NiCoE have participated in this study, which has demonstrated symptomatic improvement in greater than 50% of patients with PTSD and statistically significant improvement on every item on the Neurobehavior Symptom Inventory. Advanced analysis of a large data set is ongoing.
March 2012	<p>The ViRTiCo-BP Trial: Virtual Reality Therapy and Imaging in Combat Veterans with Blast Injury and Posttraumatic Stress Disorder</p> <p>To demonstrate that Virtual Reality Exposure Therapy (VRET) is feasible for the treatment of combat-related PTSD and establish an initial estimate of the efficacy of VRET in combat veterans. In order to demonstrate the fMRI can distinguish between four groups of Operation Iraqi Freedom or Operation Enduring Freedom veterans: blast exposure and PTSD; blast exposure and no PTSD; no blast exposure, with PTSD; no blast exposure or PTSD.</p>	USUHS	Currently enrolling subjects and controls.

START DATE	STUDY NAME AND DESCRIPTION	INSTITUTIONAL AFFILIATIONS	STATUS UPDATE
December 2011	<p>Predictors of PTSD and Post Concussive Syndrome (PCS) in OIF/OEF Veterans</p> <p>To identify those who develop PTSD or PCS from a cohort of initially healthy combat veterans, recruited within 2 months after returning from Iraq or Afghanistan, as well as factors obtained at the time of the initial evaluation, that prove to be most strongly associated with subsequent PTSD and PCS diagnosis.</p>	<p>Uniformed Services University (USU)</p> <p>WRNMMC</p>	Recruitment closed and data analysis ongoing.
October 2011	<p>National Capital Consortium Evaluation of MRI Hardware and Software in Control Subjects</p> <p>Develop and evaluate software and hardware used with MRI at 3.0 Tesla to assess brain tissue structure and function in order to develop neuroimaging techniques for the MRI scanner, as opposed to examining a specific disease state. This project uses healthy control subjects for methodology development which can later be applied to TBI patients.</p>	Internal to the NICoE	Currently seeking to recruit 250 controls.
March 2011	<p>NICoE TBI MEG Core Project</p> <p>Develop imaging modalities to best translate MEG findings through functional MRI.</p>	National Institute of Health	Currently enrolling subjects and controls.
January 2010	<p>Brain Indices of Risk for PTSD and mTBI</p> <p>The purpose of this study is to improve our ability to predict PTSD in service members who have sustained mTBI. Within the study, measures of brain structure and function are evaluated to identify markers of risk for PTSD.</p>	WRNMMC Fort Belvoir	The NICoE continues to provide necessary imaging support for this study.

GRANT PROPOSALS PENDING IRB APPROVAL FOR 2013

STUDY NAME AND DESCRIPTION	INSTITUTIONAL AFFILIATIONS	STATUS UPDATE
<p>Targeted Evaluation, Action, and Monitoring of TBI (TEAM-TBI) TEAM-TBI is a research clinical trial that brings together TBI patients, advanced evaluation methods, and world class experts in a monitored, multiple interventional trial design to address the heterogeneity of TBI and identify evidence-based treatment protocols. The goal is to confirm efficacious targeted therapies for TBI and provide deployable protocols and technology for large-scale cost-effective diagnosis and management.</p>	The University of Pittsburgh The NiCoE Naval Medical Center San Diego (NMCS)	Grant funded awaiting IRB approval.
<p>A pilot study of bilateral prefrontal transcranial magnetic stimulation (TMS) to treat the symptoms of mTBI and PTSD The NiCoE is conducting a double blind sham controlled trial looking at efficacy of TMS for PTSD symptoms in the PH/mTBI population. Sixty patients will be randomized in a 1:1 fashion to either active treatment of sham for 27 sessions over 7 weeks. Non-responders who received sham will be offered unblended active treatment. Study funded by CNRM, awaiting IRB approval.</p>	USU DVBIC	Grant funded awaiting IRB approval.
<p>NiCoE Network Research Program Infrastructure The NiCoE Network Research Program seeks funding to establish essential research personnel to execute our research portfolio, foster relationships with USU partners and NiCoE Satellite Centers, and optimize collaborative relationships with subject matter experts at other government and private sector institution.</p>	USU NiCoE Belvoir NiCoE Lejeune WRNMMC	Grant funded pending execution of dollars.
<p>Potential Utility of Sleep and Hypoxia Evaluations for Assessment of mTBI Patients Subtle, long-term mTBI-related deficits may be minimized under unstressed "normal" day-to-day circumstances of adequate sleep, and normal availability of oxygen. However, stressors are common in military performance (sleep-deprivation, hypoxia due to altitude and unpressurized air flight). This study explores whether stressors have disproportionate negative effects on persons with mTBI.</p>	WRAIR	Grant funded.
<p>Integrated Eye Tracking and Neural Monitoring for Enhanced Assessment of mTBI The Primary Investigator for this study is Dr. Mark Ettenhofer, USU. The study will aim to develop and validate a single system for evaluation of mTBI, integrating both EEG-based measures of neurocognitive effort, and eye tracker-based measures of saccadic reaction time. The NiCoE provides support for the neuroimaging component of this study, including protocol design, image acquisition and data analysis.</p>	USU Honeywell	Grant funded and has received IRB approval.
<p>Genomic Determinance Patterns Pre- and Post- NiCoE Skills-Based Training: Measuring the Relaxation Response in Service Member's with PTSD and TBI The purpose of this study is to identify genetic expression biomarkers which correlate with the clinical manifestations of comorbid TBI and PTSD, and to use unique epigenetic signature changes as a marker of response to the clinical therapeutic mind-body techniques employed for stress reduction during the 4-week intensive outpatient NiCoE admission. One hundred twenty-five service members will be enrolled in the study with blood samples drawn on admission, at 2 weeks and at discharge to evaluate primary gene expression patterns and genomic changes correlating with changes in the PCL-M and autonomic changes as measured by heart rate variability.</p>	Harvard Medical School Beth Israel Deaconess Medical Center	Grant funded.

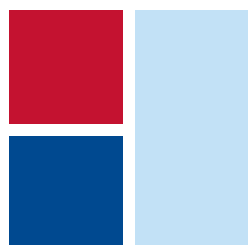

ADDENDUM

Since its founding in 2010, the NICoE staff has published journal articles, presented posters, given lectures and served in key administrative roles.

JOURNAL ARTICLES

Caban, J., Riedy, G., & Green, S. (2013). **Characterization of T2 Hyperintensity Lesions in Patients with Mild Traumatic Brain Injury.** Proceedings SPIE 8670, *Medical Imaging 2013: Computer-Aided Diagnosis*, 86702U.

Graner, J., Oakes, T., French, L., & Riedy, G. (2013). **Functional MRI in the Investigation of Blast-Related Traumatic Brain Injury.** *Frontiers in Neurology*, 4, 1-18.

Lathan, C., Spira, J. L., **Bleiberg, J.**, Vice, J., & Tsao, J. L. (2013). **Defense Automated Neurobehavioral Assessment (DANA)-psychometric properties of a new field-deployable neurocognitive assessment tool.** *Military Medicine*, 178, 365-371.

Liu, W., Wang, B., Yeh, P., Nathan, D., Graner, J., Tang, H., . . . Riedy, G. (2013). **Perfusion Deficits in Patients with Mild Traumatic Brain Injury Characterized by Dynamic Susceptibility Contrast MRI.** *NMR in Biomedicine*, 26, 651-663.

Temme, L., **Bleiberg, J.**, Reeves, D., Still, D. L., Levinson, D., & Browning, R., (2013). **Uncovering Latent Deficits due to Mild Traumatic Brain Injury (mTBI) By Using Normative Hypoxia Stress.** *Frontiers in Neurology*, 4,1-7.

Tepe, V., Cernich, A., & **Kelly, J. P.** (2013). **Polytraumatic TBI: Perspectives from Military Medicine.** *Psychiatric Annals*, 43, 308-312.

Yeh, P., Wang, B., Oakes, T. R., French, L. M., Pan, H., Graner, J., . . . Riedy, G., (2013). **Postconcussional Disorder and PTSD Symptoms of Military-related Traumatic Brain Injury Associated with Compromised Neurocircuitry.** *Human Brain Mapping*, in press.

Yeh, P., Riedy, G., & Oakes, T. R. (2012). **Diffusion Tensor Imaging and Its Application to Traumatic Brain Injury: Basic Principles and Recent Advances.** *Open Journal of Medical Imaging*, 2, 137-161.

Beardslee, W., Lester, P., Klosinski, L., **Koffman, R.**, Woodward, K., Nash, W., . . . Leskin, G. (2011). **Family-centered Preventive Interventions for Military Families: Implications for Implementation Science.** *Prevention Science*, 12, 339-348.

Haacke, E., Duhaime, A. C., Gean, A. D., **Riedy, G.**, Wintermark, M., Mukherjee, P., . . . Smith, D. H. (2010). **Common Data Elements in Radiologic Imaging of Traumatic Brain Injury.** *Journal of Magnetic Resonance Imaging*, 32, 516-543.

BOOK CHAPTERS

Bleiberg, J. & Wolkenberg, F. (2013). *Cognitive Resource Alterations following Recovery from Concussion* In J. Giordano & P. Waters (Eds.), **Brain Injury: Spectrum Effects and Implications** (123-132). Arlington: Potomac Institute Press.

PEER-REVIEWED POSTER PRESENTATIONS

Merrifield, W., Popesu, A., Popescu, M., Balbir, A., Balkin, T., Bleiberg, J., . . . DeGraba, T. (2013, August). **Localization of delta slow wave activity in mild traumatic brain injury using independent component analysis.** Poster presented at the *National Neurotrauma Society Annual Meeting & Symposium*, Nashville, Tennessee.

Ollinger, J., Hurley, S., Alexander, A., & Riedy, G. (2013, July). **A constrained estimator of myelin water fraction from steady-state data.** Poster presented at *International Society for Magnetic Resonance in Medicine Annual Meeting & Exhibition*, Salt Lake City, Utah.

Caban, J., Lesage, S., Riedy, G., & Panettiere, A. (2013, June). **The associations of sleep disturbances and neuroimaging findings among military patients diagnosed with TBI.** Poster presented at the *Annual Meeting of the Associated Professional Sleep Societies*, Bethesda, Maryland.

Evans, J., **Graner, J., Joy, D., Oakes, T., & Riedy, G.** (2013, June). **Heterogeneity in the TBI subject population in response to go/no go task.** Poster presented at the *Organization for Human Brain Mapping Conference*, Seattle, Washington.

Graner, J., Wang, B., Yeh, P., Pan, H., Liu, W., Ollinger, J., . . . Riedy, G. (2013, June). **Group-wise effect of global signal regression on a resting state analysis of TBI patients and controls.** Poster presented at the *Organization for Human Brain Mapping Conference*, Seattle, Washington.

Oakes, T., Caban, J., Bryant, A., Joy, D., Ollinger, J., Jurgens, J., & Riedy, G. (2013, June). **PET-FDG metabolism is correlated with multiple TBI-related symptoms in military TBI.** Poster presented at the *Human Brain Mapping Conference*, Seattle, Washington.

Pan, H., Graner, J., Wang, B., Liu, W., Tang, H., Yeh, P., . . . Riedy, G. (2013, June). **Altered resting-state connectivity correlating stroop task performance: a study of military mTBI.** Poster presented at the *Organization for Human Brain Mapping Conference*, Seattle, Washington.

Yeh, P., Ollinger, J., Wang, B., Joy, D., Liu, W., Oakes, T., Riedy, G. (2013, June). **Multimodal neuroimaging of military-related traumatic brain injury - A Pilot Study.** Poster presented at the *Organization for Human Brain Mapping Conference*, Seattle, Washington.

Caban, J., Green, S., & Riedy, G. (2013, January). **Characterization of T2 hyperintensity lesions in patients with mild traumatic brain injury.** Poster presented at the *SPIE Medical Imaging Conference*, Orlando, Florida.

Kodosky, P., Pape, M., & Smith, L. (2013, January). **Physical therapy management using a multifaceted, holistic approach: A case report.** Poster presented at the *Walter Reed National Military Medical Center Research Competition*, Bethesda, Maryland.

Nousak, J. (2013, January). **When the hearing test says "You're OK", and the service member says "huh?" Effective Aural Rehabilitation for Service Members with mTBI and Auditory Deficits.** Poster presented at the *Walter Reed National Military Medical Center Research Competition*, Bethesda, Maryland.

Pape, M., & Snyder, J. (2013, January). **An interdisciplinary approach to vestibular disturbances: A case study.** Poster presented at the *Walter Reed National Military Medical Research Competition*, Bethesda, Maryland.

Rosebrock, A., **Caban, J., Figueroa, J., Gierach, G., Linville, L., Hewitt, S., & Sherman, M.** (2013, January). **Quantitative Analysis of TDLUs using Adaptive Morphological Shape Techniques.** Poster presented at *Proceedings of the SPIE Medical Imaging 2013: Digital Radiology*, Lake Buena Vista, Florida.

Caban, J., Green, S., & Riedy, G. (2012, September). **Morphological analysis of T2 hyperintensity lesions in patients with mild traumatic brain injury.** Poster presented at the *Symposium on Deep Brain Connectomics*, Clermont-Ferrand, France.

Nathan, D., **Wang, B., Wolfowitz, R., Liu, W., Yeh, P., Graner, J., . . . Riedy, G.** (2012, August). **Examining intrinsic thalamic resting state networks using graph theory analysis: Implications for mTBI detection.** Poster presented at the *34th Annual International Conference of the Institute of Electrical and Electronics Engineering in Medicine and Biology Society*, San Diego, California.

Graner, J., Seonjoo, L., Wang, B., Yeh, P., Pan, H., Liu, W., . . . Riedy, G. (2012, July). **Group differences in global signal correlation between military TBI patients and controls.** Poster presented at the *National Neurotrauma Society Conference*, Phoenix, Arizona.

Nathan, D., **Yeh, P., Wolfowitz, R., Harper, J., Liu, W., Graner, J., . . . Riedy, G.** (2012, July). **Exploring spatial variations in resting-state default mode network in mild traumatic brain injury using independent component analysis.** Poster presented at the *National Neurotrauma Society Conference*, Phoenix, Arizona.

Ollinger, J., Hurley, S., Alexander, A., & Riedy, G. (2012, July). **Constrained estimation at mcDESPOT.** Poster presented at the *Gordon Research Conference at in Vivo Magnetic Resonance Imaging*, Waterville, Maine.

Liu, W., Nathan, D., Yeh, P., Tang, H., Wolfowitz, R., Harper, J., . . . Riedy, G. (2012, May). **Perfusion deficits in patients with mild traumatic brain injury characterized with dynamic susceptibility contrast imaging: Manual vs. auto selection of arterial input function.** Poster presented at the *International Society for Magnetic Resonance in Medicine Annual Conference*, Melbourne, Australia.

Liu, W., Nathan, D., Yeh, P., Tang, H., Wolfowitz, R., Harper, J., . . . Riedy, G. (2012, May). **Positive contrast imaging of microhemorrhages in patients with traumatic brain injury.** Poster presented at the *International Society for Magnetic Resonance in Medicine Annual Conference*, Melbourne, Australia.

Tang, H., Liu, E., **Pan, H., Liu, W., Selwyn, R., Oakes, T., & Riedy, G.** (2012, May). **Quantitative susceptibility mapping of hemorrhages in TBI Using the 3D multi-echo gradient Echo MRI at 3T.** Poster presented at the *International Society for Magnetic Resonance in Medicine Annual Conference*, Melbourne, Australia.

Wang, B., Yeh, P., Liu, W., Graner, J., Tang, H., Pan, H., . . . Riedy, G. (2012, May). **Investigating of T2* mapping on combat-related TBI on combat-related TBI patient.** Poster presented at

the *International Society for Magnetic Resonance in Medicine Annual Conference*, Melbourne, Australia.

Yeh, P., Wang, B., Oakes, T., Graner, J., Pan, H., Liu, W., . . . Riedy, G. (2012, May). **Structural connectivity of military-related traumatic brain injury and its relations with neurocognition.** Poster presented at the *International Society for Magnetic Resonance in Medicine Annual Conference*, Melbourne, Australia.

Yeh, P., Wang, B., Oakes, T., Graner, J., Liu, W., French, L., & Riedy, G. (2011, December). **DTI and tractography of military-related traumatic brain injury.** Poster presented at the *Traumatic Brain Injury Spectrum Conference*, Bethesda, Maryland.

Graner, J., Yeh, P., Pan, H., Wang, B., Oakes, T. R., Liu, W., . . . Riedy, G. (2011, June). **Resting-state fMRI dual-regression connectivity analysis on a military traumatic brain injury population.** Poster presented at the *Human Brain Mapping Conference*, Quebec City, Canada.

Yeh, P., Wang, B., Oakes, T. R., Graner, J., Pan, H., Liu, W., . . . Riedy, G. (2011, June). **Limbic White Matter Connectivity in Military-related Mild and Moderate Traumatic Brain Injury.** Poster presented at the *Human Brain Mapping Conference*, Quebec City, Canada.

Graner, J., Pan, H., Yeh, P., Wang, B., Oakes, T. R., Liu, W., . . . Riedy, G. (2011, May). **fMRI of Working Memory in Military Traumatic Brain Injury.** Poster presented at the *ISMRM annual conference*, Ottawa, Canada.

Tang, H., Sati, P., **Yeh, P., Liu, W., Wang, B., Pan, H., . . . Riedy, G.** (2011, May). **Noninvasive Measurement of TBI: High Resolution Multiecho Susceptibility Weighted MRI at 3T.** Poster presented at the *ISMRM 19th Annual Meeting & Exhibition*, Montreal, Canada.

Yeh, P., Wang, B., Oakes, T., French, L., Graner, J., Pan, H., . . . Riedy, G. (2011, May). **Diffusion tensor imaging and tractography of military-related traumatic brain injury and correlation with neuropsychological functions.** Poster presented at the *International Society for Magnetic Resonance in Medicine Annual Conference*, Ottawa, Canada.

LECTURES

Livornese, K., Vedder, J., & Brads-Pitt, T. (2013, November). **NICoE Integrated Care Model.** *Sigma Theta Tau International Chesapeake Conference*, Lecture conducted from Indianapolis, Indiana.

Panettiere, A. (2013, October). **Sleep in TBI and PTSD.** *Grand Rounds. Lecture from Satellite Camp LeJeune (Intrepid Spirit)*, North Carolina.

Temme, L., J. Bleiberg, J. (2013, August). **Uncovering latent deficits due to mild traumatic brain injury by using normobaric hypoxia stress.** *Military Health Science Research Symposium*, Lecture conducted from Fort Lauderdale, Florida.

DeGraba, T. (2013, May). **Studying diagnostic testing and treatment of traumatic brain injury.** *FDA MCMi 2nd Annual Regulatory Science Symposium*. Lecture conducted from Silver Spring, MD.

Nousak, J. K. (2013, May). **Audiological Assessment and Management for Service Members with Traumatic Brain Injury (TBI) and Psychological Health (PH) issues.** *Annual GN Resound national meeting of DoD and VA audiologists' training*. Lecture conducted from New Orleans, Louisiana.

Stewart, F., Staver, T., Rawlings, J., & Soto, R. (2013, March). **Biofeedback in interdisciplinary care at the National Intrepid Center of Excellence.** *Association for Applied Psychophysiology and Biofeedback (AAPB) 44th Annual Scientific Meeting*. Lecture conducted from Portland, Oregon.

Caban, J. (2012, October). **Analyzing the complex interactions of mild TBI: Research and challenges.** *Defense Advanced Research Projects Agency (DARPA)*, Lecture conducted from Arlington, Virginia.

DeGraba, T. (2012, October). **Real World Application of the Common Data Elements.** *Expert panel on data collection and use of common data elements for advancing knowledge in TBI.* American Congress of Rehabilitation Medicine Meeting. Vancouver, Canada.

DeGraba, T. (2012, August). **Research Platform for Understanding Pathophysiological Changes in Service Members with Comorbid TBI and PH Conditions.** *2012 Military Health Research Symposium*. Lecture conducted from Fort Lauderdale, Florida.

Spira, J., **Bleiberg, J., Lathan, C., & Tsao, J.** (2012, August). **Defense Automated Neurobehavioral Assessment (DANA): A field-deployable tool for assessing concussion and deployment stress.** *Naval Command Combat Operational Stress Control Conference, 2012 Military Health System Research Symposium*. Lecture conducted from Fort Lauderdale, Florida.

DeGraba, T. (2012, June). **Interdisciplinary Care Model in Service Members with Combat and Mission Related Traumatic Brain Injury and Psychological Health Conditions.** *9th Annual World Congress of the Society for Brain Mapping and Therapeutics*. Lecture conducted from Toronto, Canada.

Kelly, J. P. (2012, April). **National Intrepid Center of Excellence (NICoE) and Signs and Symptoms of Traumatic Brain Injury.** *International Health Partnership for Peace Workshop*. Lecture conducted from Ramstein Air Base, Germany.

Riedy, G., Wolfowitz, R., Harper, J., Melford, C., & Oakes, T. R. (2012, April). **Neuroimaging of traumatic brain injury in the military at the National Intrepid Center of Excellence.** *ASNR 50th Annual Meeting & The Foundation of the ASNR Symposium 2012*. Lecture conducted from New York, New York.

Kelly, J. P. (2012, March). **Longitudinal Study of Medical Requirements for Wounded, Ill or Injured Service Members Conference.** *Traumatic Brain Injury Panel, Hosted by the Assistance Secretary of Defense for Health Affairs*. Lecture conducted from Washington, DC.

Kelly, J. P. (2012, March). **The Signs and Symptoms of TBI.** *Train the Trainer*, California Area Health Education Center (AHEC) Statewide office at University of California San Francisco. Lectures conducted from Los Angeles, California, Denver, Colorado, Dallas, Texas.

Kelly, J. P. (2012, January). **Brain Injury: The U.S. Military Experience and The National Intrepid Center of Excellence: Advancing Our Understanding of Military TBI and Psychological Health Conditions.** *Brain Injury Summit.* Lecture conducted from Beaver Creek, Colorado.

Kelly, J. P. (2012, January). **National Intrepid Center of Excellence, Wounded Warrior Track.** *Military Health System Conference.* Lecture conducted from National Harbor, MD.

Panettiere, A. (2011, December). **The impact of TBI and PTSD on Sleep.** *4th Annual Trauma Spectrum Conference.* Lecture conducted from Bethesda, Maryland.

Kelly, J. P. (2011, September). **CNS Injury III - Concussion.** *University of Colorado.* Lecture conducted from Denver, Colorado.

Kelly, J. P. (2011, September). **Veterans and Department of Defense Issues and Blast Injury Institute Panel.** *Annual Conference on Brain Injury.* Lecture conducted from New Orleans, Louisiana.

Kelly, J. P. (2011, September). **Traumatic Brain Injury.** *Center for Deployment Psychology at Uniformed Services University of the Health Services.* Lecture conducted from Bethesda, Maryland.

Kelly, J. P. (2011, August). **National Intrepid Center of Excellence (NICoE) Introduction, Patient Panel, and Philosophy & Methodology.** *NICoE Summit.* Lecture conducted from Arlington, Virginia.

Kelly, J. P. (2011, June). **National Intrepid Center of Excellence (NICoE) and the Military.** *Federal Interagency Conference on Traumatic Brain Injury.* Lecture conducted from Washington, DC.

Kelly, J. P. (2011, June). **The Natural History of mild TBI: Lessons Learned from Sports Concussion Research on Acute and Chronic Effects.** *Federal Interagency Conference on Traumatic Brain Injury.* Lecture conducted from Washington, DC.

Kelly, J. P. (2011, June). **National Intrepid Center of Excellence (NICoE).** *The Traumatic Brain Injury Model Systems Project Directors Meeting.* Lecture conducted from Arlington, Virginia.

Kelly, J. P. (2011, June). **Post-Traumatic Stress Disorder.** *Grand Rounds for Behavioral Health.* Lecture conducted from Fort Belvoir, Virginia.

Kelly, J. P. (2011, June). **Sports Related Concussion and Mild TBI & CNS Injury (Brain & Spine) on Veterans of Iraq and Afghanistan War.** *Foundation of the American Society of Neuroradiology Symposium.* Lecture conducted from Seattle, Washington.

Kelly, J. P. (2011, May). **Recovery of Function after Brain Injury.** *Johns Hopkins Traumatic Brain Injury National Conference.* Lecture conducted from Baltimore, Maryland.

Kelly, J. P. (2011, May). **Concussion as a Military Concern.** *Mount Sinai Medical Center Concussion Definition Consortium- An Evidence-Based Project.* Lecture conducted from New York, New York.

Kelly, J. P. (2011, May). **Mild Traumatic Brain Injury/Concussion Pathology and Identification.** *DiSepio Symposium Series.* Lecture conducted from Loretto, Pennsylvania.

Kelly, J. P. (2011, February). **Invisible Wound of Warriors, TBI & PTSD.** *Western Colorado Area Health Education Center Conference.* Lecture presented from Grand Junction, Colorado.

Kelly, J. P. (2011, January). **Cutting-Edge Multi-Disciplinary Care for the TBI Patient: National Intrepid Center of Excellence.** *Military Health System Conference.* Lecture conducted from Bethesda, Maryland.

Kelly, J. P. (2010, December). **Traumatic Brain Injury.** *Brain and Behavior Conference Tulane University.* Lecture conducted from New Orleans, Louisiana.

Riedy, G. (2010, November). **Neuroimaging in TBI.** *WSU Internal TBI Workshop, Advanced Technology Applications for Combat Casualty Care (ATACCC), DVVIC Annual Traumatic Brain Injury Military Training.* Lecture conducted from Bethesda, Maryland.

LETTERS TO THE EDITOR

Marion, D., **Kelly, J. P.**, Grimes, J., & Flores, III, E. (2013, July). **Loss of Consciousness and Concussion** [Letter to the Editor]. *Annals of Neurology*, 74(1), 152-153. Administrative Positions / Conference Coordination and Facilitation

ADMINISTRATIVE POSITIONS / CONFERENCE COORDINATION AND FACILITATION

Kelly, J. P. Co-Chairman, (2013, July). **Brain Trauma-Related Neurodegeneration Strategies to Define, Detect and Predict**, *Sports and Health Research Program for National Institutes of Health (NIH), Foundation for the NIH and National Football League (NFL)*, Bethesda, Maryland.

Kelly, J. P. Chairman, Symposium (2011, August). **National Intrepid Center of Excellence (NICoE) Summit**. *The office of Assistant Commandant of the Marine Corps, Vice Chief of Staff of the Army and NICoE*, Arlington, VA.

Kelly, J. P. Moderator, Symposium (2011, March). **The Regeneration of Brain Synapses Science, Implications, and Opportunities Center for Brain Science & Metabolism**, *the National Intrepid Center of Excellence, and the Massachusetts Institute of Technology*, Bethesda, MD.



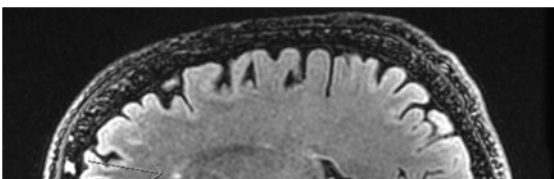

NICoE 
 National Intrepid
 Center of Excellence

**4860 South Palmer Road
 Bethesda, MD 20889**

WWW.NICoE.CAPMED.MIL
 EMAIL: NICoE@HEALTH.MIL